

AFPD018/CCT

18W CCT Selectable Slimline
Flat Panel Downlight

Orbit CCT 18

PRODUCT FEATURES

- 5 Year Guarantee
- CCT Selectable (3000K/4000K/6000K)
- UV Stable
- Flicker Free Driver
- Low Glare Edge-Lit Design
- Slimline Design
- Ideal For Use In Shallow Ceiling Voids
- High Luminous Efficiency
- Plug & Play DC Connector Driver
- Uniform Light Output
- 0-10V & DALI Dimmable Options Available

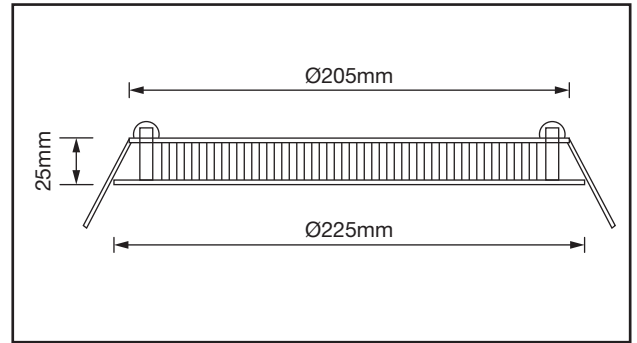

TECHNICAL SPECIFICATIONS

PRODUCT CODE	AFPD018/CCT
Frame Colour	White
Wattage	18W
Operating Voltage	220-240V AC
Frequency	50-60Hz
CCT	3000K, 4000K, 6000K
CRI	>80
Power Factor	>0.5
Beam Angle	120°
Peak Intensity	510cd
Lifetime To LM80	30,000 Hrs
Useful Luminous Flux (LM)	≤1750lm
Switching Cycles	<15,000
Ambient Operating Temperature	-20°C ~ 50°C
SDCM	<8
Starting Time	Instant Start
Ingress Protection	IP20
LED Chips	SMD2835
Guarantee	5 Years
Cut Out	Ø205mm
Overall Diameter	Ø225mm
Class Driver	II
Class Downlight	III

Standard
AFPD018/CCT

Mains Dimmable
AFPD018TD/CCT

DALI
AFPD018/CCT/DALI

0-10V Dimmable
AFPD018/CCT/0-10

**Standard
Emergency**
AFPD018/CCT/EM

**Mains Dimmable
Emergency**
AFPD018TD/CCT/EM

**DALI
Emergency**
AFPD018/CCT/DALI/EM

**0-10V Dimmable
Emergency**
AFPD018/CCT/0-10/EM

**Standard
Emergency Self Testing**
AFPD018/CCT/EM/ST

**Mains Dimmable
Emergency Self Testing**
AFPD018TD/CCT/EM/ST

**DALI
Emergency Self Testing**
AFPD018/CCT/DALI/EM/ST

**0-10V Dimmable
Emergency Self Testing**
AFPD018/CCT/0-10/EM/ST

